

IC-02A/AT

144MHz FM TRANSCEIVER

INSTRUCTION MANUAL



TABLE OF CONTENTS

| | | | |
|---------|-----|---------------------------|----------|
| SECTION | 1 | FEATURES | 1 |
| SECTION | 2 | SPECIFICATIONS | 3 |
| SECTION | 3 | ACCESSORIES..... | 5 |
| SECTION | 4 | PRE-OPERATION | 6 |
| SECTION | 5 | CONTROL FUNCTIONS..... | 9 |
| SECTION | 6 | OPERATION | 16 |
| | 6-1 | RECEIVING | 16 |
| | 6-2 | TRANSMITTING | 17 |
| | 6-3 | KEY FUNCTIONS..... | 19 |
| | 6-4 | DIAL MODE..... | 21 |
| | 6-5 | MEMORY CHANNEL MODE | 30 |
| | 6-6 | PRIORITY FUNCTION..... | 32 |
| | 6-7 | LOCK FUNCTION..... | 34 |
| | 6-8 | SCANNING OPERATIONS | 34 |
| SECTION | 7 | INSIDE VIEWS | 39 |
| SECTION | 8 | TROUBLESHOOTING | 41 |
| SECTION | 9 | BLOCK DIAGRAM | 45 |
| SECTION | 10 | SCHEMATIC DIAGRAM..... | SEPARATE |

SECTION 1 FEATURES

●SYNTHESIZED HANDHELD TRANSCEIVER

This small, light-weight handheld transceiver comes in handy for use any time; whether outdoors, in a car, or at home. The operating frequency can be entered by pushing the front panel keys as can the frequency step rate, duplex offset frequency and subaudible tone (IC-02AT only).

●MULTI-PURPOSE SCANNING

Memory scan allows you to monitor all memory channels. Programmed scan provides scanning between two programmed frequencies. Auto-stop is also provided which stops the scan when a signal is received, but allows the scan to resume when the signal goes away.

●10 MEMORY CHANNELS

The IC-02A/AT has ten memory channels and each channel stores the operating frequency as well as duplex/simplex, duplex offset and subaudible tone frequency (IC-02AT only) information for your operating convenience.

●SLIDE-ON BATTERY

The supplied IC-BP4 slides on or off the IC-02A/AT for easy removal or installation. A one button quick-release lock is provided to prevent unwanted removal.

● **RUGGED CONSTRUCTION**

Constructed with an all metal chassis, stainless steel battery slide rails, reinforced die-cast aluminum back as well as moisture and dust resistant seals, the IC-02A/AT is built to stand up to the most demanding environments.

● **EASY-TO-READ DISPLAY**

This set employs an easy-to-read LCD readout. This displays the operating frequency as well as the memory channel number, duplex mode, scan mode, lock function, tone encoder enable indicator, etc.

In addition an S/RF meter is provided in the form of a segmented LCD bar across the bottom of the display.

● **DUAL POWER LEVELS**

Transmitter output can be switched easily between two levels; 3W output HIGH for long distances and 0.5W LOW for short distances. Battery consumption will be minimized in the LOW power mode. The IC-BP7 power pack as an option gives 5W output and the standard aluminum case back provides superior heat sinking when the unit is run at that level.

● **VARIOUS ACCESSORIES AVAILABLE**

All IC-2 series accessories are compatible with the IC-02 series plus there are new options such as the IC-BP7 and IC-BP8 battery packs and the HS-10 headset with PTT switchbox and VOX unit options.

SECTION 2 SPECIFICATIONS

GENERAL

| | | |
|---------------------------|---------------|--|
| -Number of semiconductors | Transistors | 42 (02AT: 48) |
| | FETs | 3 |
| | ICs | 10 (02AT: 13) |
| | Diodes | 40 (02AT: 46) |
| Frequency coverage | 02A/AT: | 144MHz ~ 148MHz (Some versions cover 140MHz ~ 149.995MHz without guaranteed specifications.) |
| Frequency readout | | 6 digit 5kHz readout, LCD |
| Frequency resolution | 02A/AT: | 5kHz steps (other steps such as 10kHz, 15kHz, 20kHz and 25kHz are programmable and available by pushing the UP/DOWN buttons) |
| Frequency control | | Digital PLL synthesizer with key input |
| Frequency stability | | Within 0.002% in range of $-10^{\circ}\text{C} \sim +60^{\circ}\text{C}$ |
| Memory channels | | 10 Channels |
| Scanning | | Programmed Scan and Memory Channel Scan available |
| Usable temperature | | $-10^{\circ}\text{C} \sim +60^{\circ}\text{C}$ |
| Antenna impedance | | 50 ohms unbalanced |
| Power supply requirement | | 12 ~ 15V DC for the EXTERNAL DC POWER JACK IC-BP2 ~ IC-BP8 BATTERY PACKS are acceptable. |
| Current drain at 8.4V | Transmitting: | HIGH (3.5W) Approx. 1.1A LOW (0.5W) Approx. 0.45A |
| | Receiving: | At max audio output Approx. 140mA Squelched Approx. 35mA |

Dimensions 116.5mm(H) x 65mm(W) x 35mm(D) without battery pack.
IC-BP4 attendant battery pack: 49mm(H) x 65mm(W) x 35mm(D)
Weight 515g (IC-02A: 515g) including IC-BP4 battery pack and flexible antenna

TRANSMITTER

Output power HIGH: 3.5W with IC-BP4 (9V)
LOW: 0.5W with any ICOM battery pack
Emission mode F3E 16K0 (16F3)
Modulation system Variable reactance frequency modulation
Max. frequency deviation $\pm 5\text{kHz}$
Spurious emission More than 60dB below carrier
Microphone Built-in electret condenser microphone
Optional Speaker-microphone (IC-HM9) and Headset (HS-10) can be used.
Operating mode Simplex
Duplex (Any in-band frequency separation programmable.)

RECEIVER

Receiving system Double-conversion superheterodyne
Modulation acceptance F3E 16K0 (16F3)
Intermediate frequencies 1st: 16.9MHz 2nd: 455kHz
Sensitivity Less than $0.25\mu\text{V}$ for 12dB SINAD
Less than $0.3\mu\text{V}$ for 20dB noise quieting
Squelch sensitivity Less than $0.1\mu\text{V}$
Spurious response rejection ratio More than 60dB
Selectivity More than $\pm 7.5\text{kHz}$ at -6dB point
Less than $\pm 15\text{kHz}$ at -60dB point
Audio output power More than 500mW (at 8 ohms, 10% distortion)
Audio output impedance 8 ohms

All stated specifications are subject to change without notice or obligation.

SECTION 3 ACCESSORIES

UNPACKING

Carefully remove your transceiver from the packing carton and examine it for signs of shipping damage. Notify the delivering carrier or dealer immediately, stating full details, should any damage be apparent. We recommend you keep the shipping carton for storing, moving or reshipping the transceiver if necessary. Accessory hardware, cables, etc., are packed with the transceiver. Make sure you have removed all equipment and parts before discarding the packing material.

1. Power pack IC-BP4
(Attached to the set.) 1
2. Flexible antenna 1
3. Belt clip 1
4. Earphone. 1
5. Earphone plug. 1
6. Microphone plug 1
7. DC Power plug 1
8. Hand-strap 1
9. Rainproof cap 1

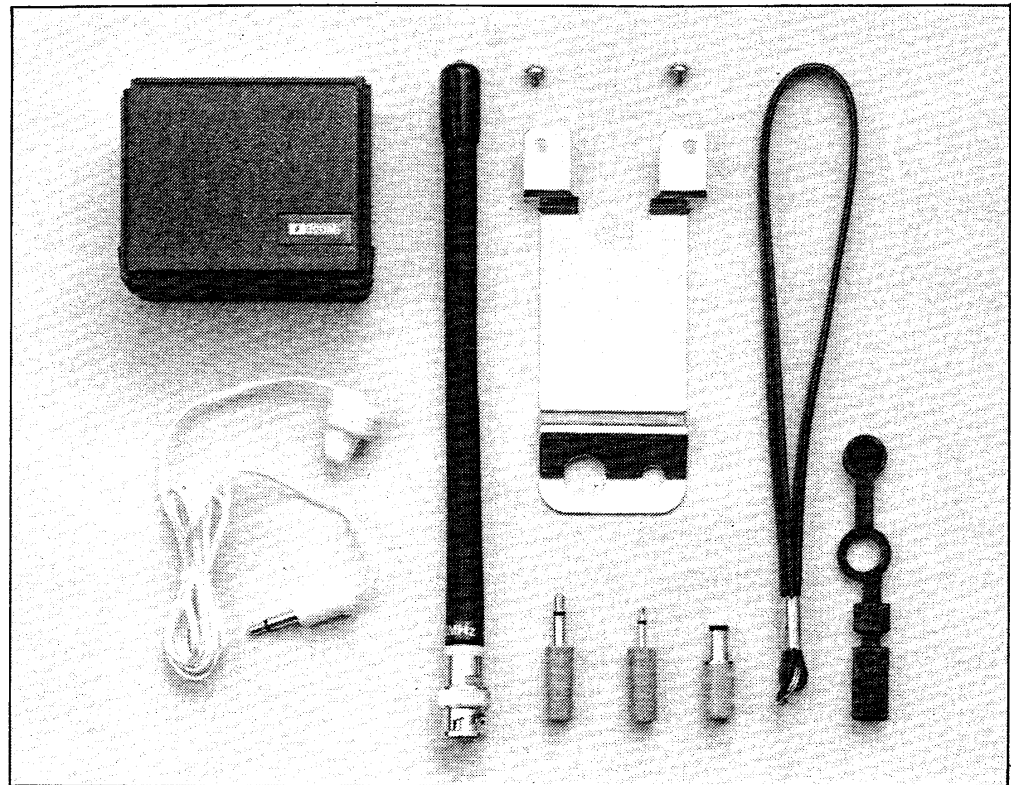

SECTION 4 PRE-OPERATION

4 - 1 BATTERY INSTALLATION

(1) Using IC-BP4

- ① Place the power switch in the OFF position. Remove the power pack from the bottom of the set by pushing the pack in the indicated direction while sliding the lock button upward. Separate the pack into two parts as follows:

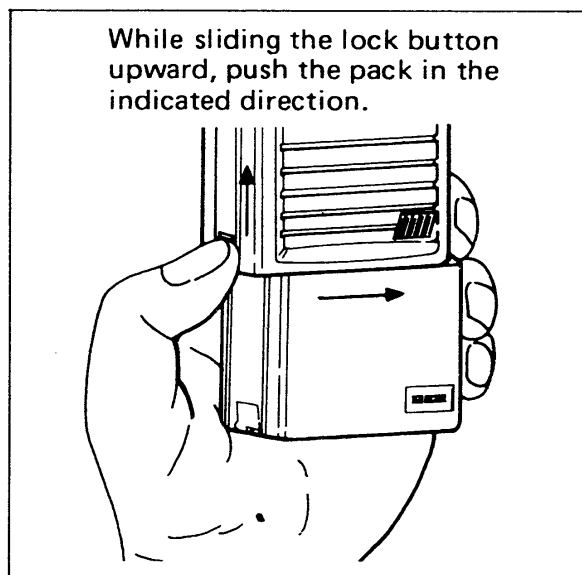

Also, AA type nickel-cadmium, rechargeable batteries can be used, but the charger for them should be the optional BC-35 charger.

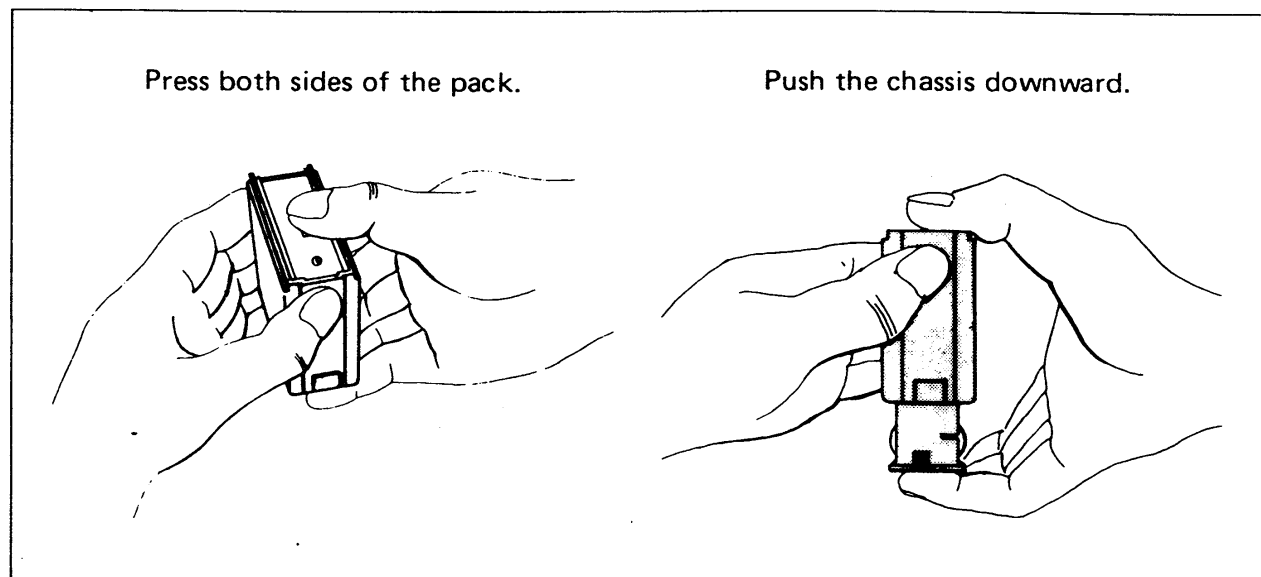

- ② The chassis holds six AA type batteries. Install batteries into each holder, according to indicated polarity. With the batteries properly in place, carefully replace the pack and slip it onto the set with the reverse procedures.

(2) EXTERNAL POWER SOURCE

For use at home or in a car, use an external power source which assures you of stable communication without concern for battery consumption.

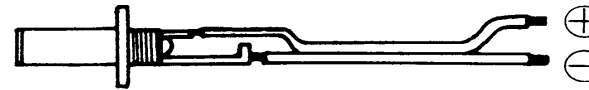

- ① Use either a 13.8V DC regulated power supply or car battery rated at over 1.5A current capability.
- ② Correctly connect the external supply as shown in the figure. If polarity is reversed, source power is cut off by the protection circuit and the unit will not operate.
- ③ When the transceiver is not used for a prolonged period, the unit is operated for extended periods by external power only, or when the batteries are exhausted, remove the batteries to protect the unit from possible damage by battery leakage (when using IC-BP4 with alkaline batteries).

4 - 2 EXTERNAL ANTENNA

- ① Select a high performance antenna (a multi-element beam or gain antenna) and set it up in the highest possible position.
- ② Use a 50 ohm antenna and coaxial cable with BNC plug.

4-3 FOR OUTDOOR USE

1. Attach the supplied power pack. (Refer to "BATTERY INSTALLATION")
2. Attach the supplied hand strap and belt clip (as shown in the drawings).
3. Attach the flexible rubber antenna.

ATTACHMENT OF HAND STRAP AND BELT CLIP

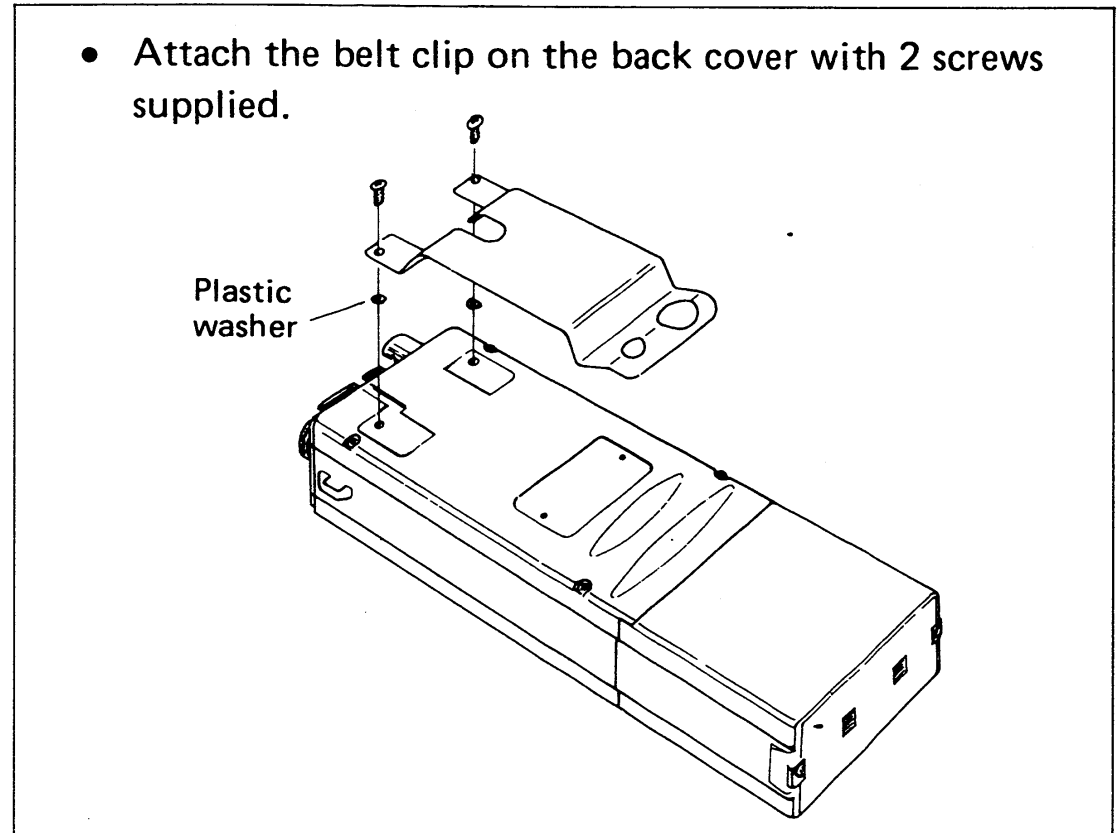
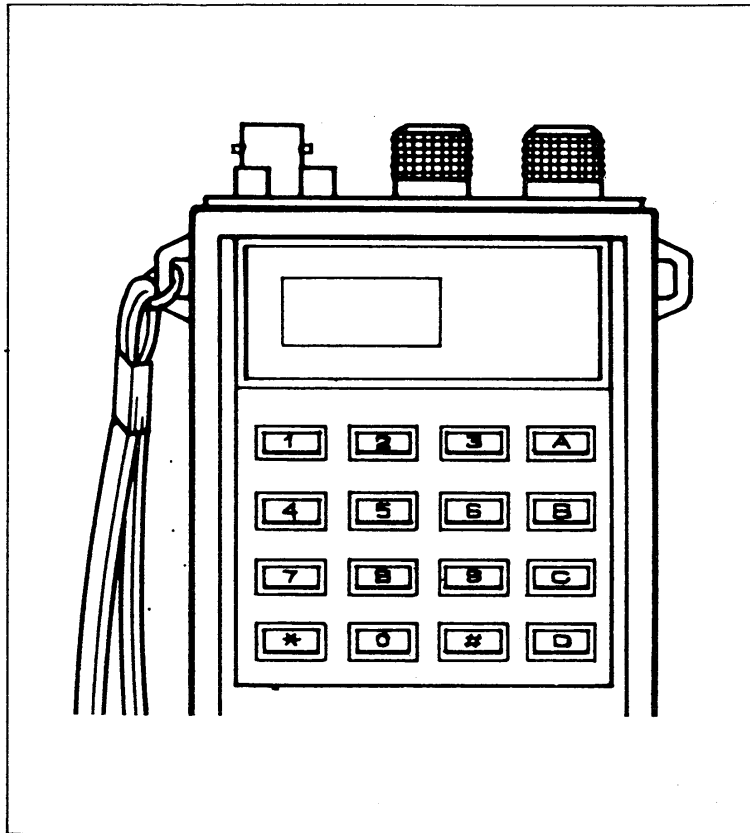

SECTION 5 CONTROL FUNCTIONS

TOP PANEL

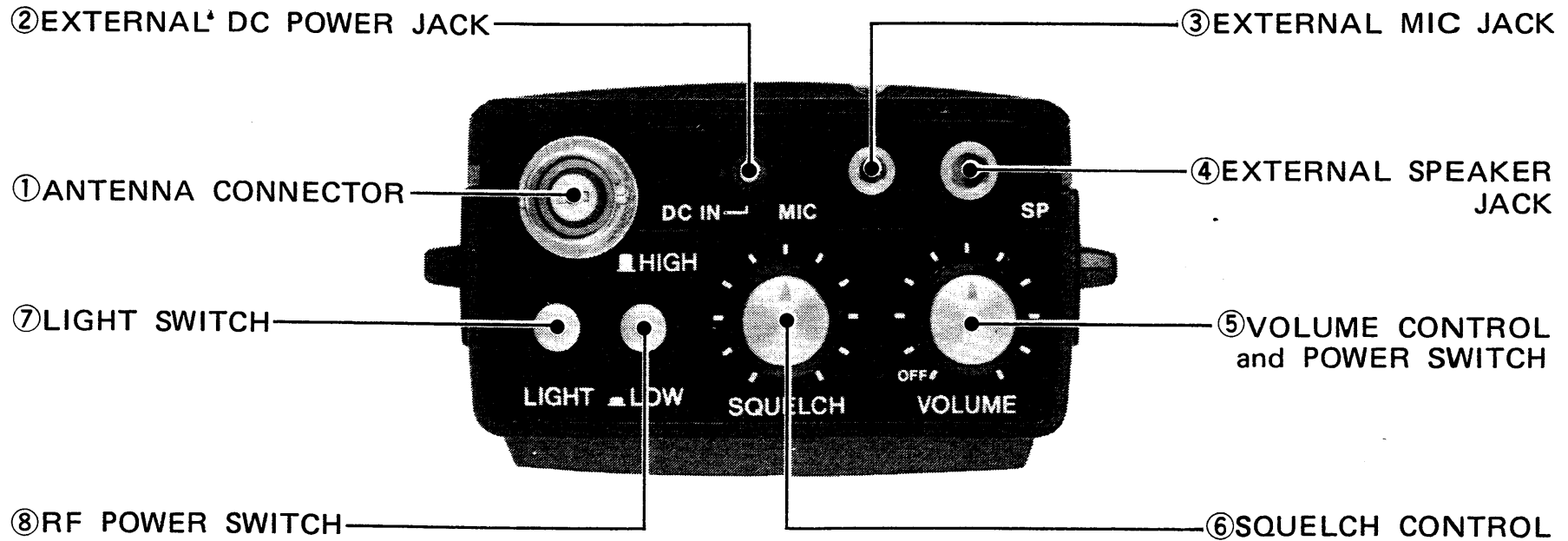

FRONT PANEL

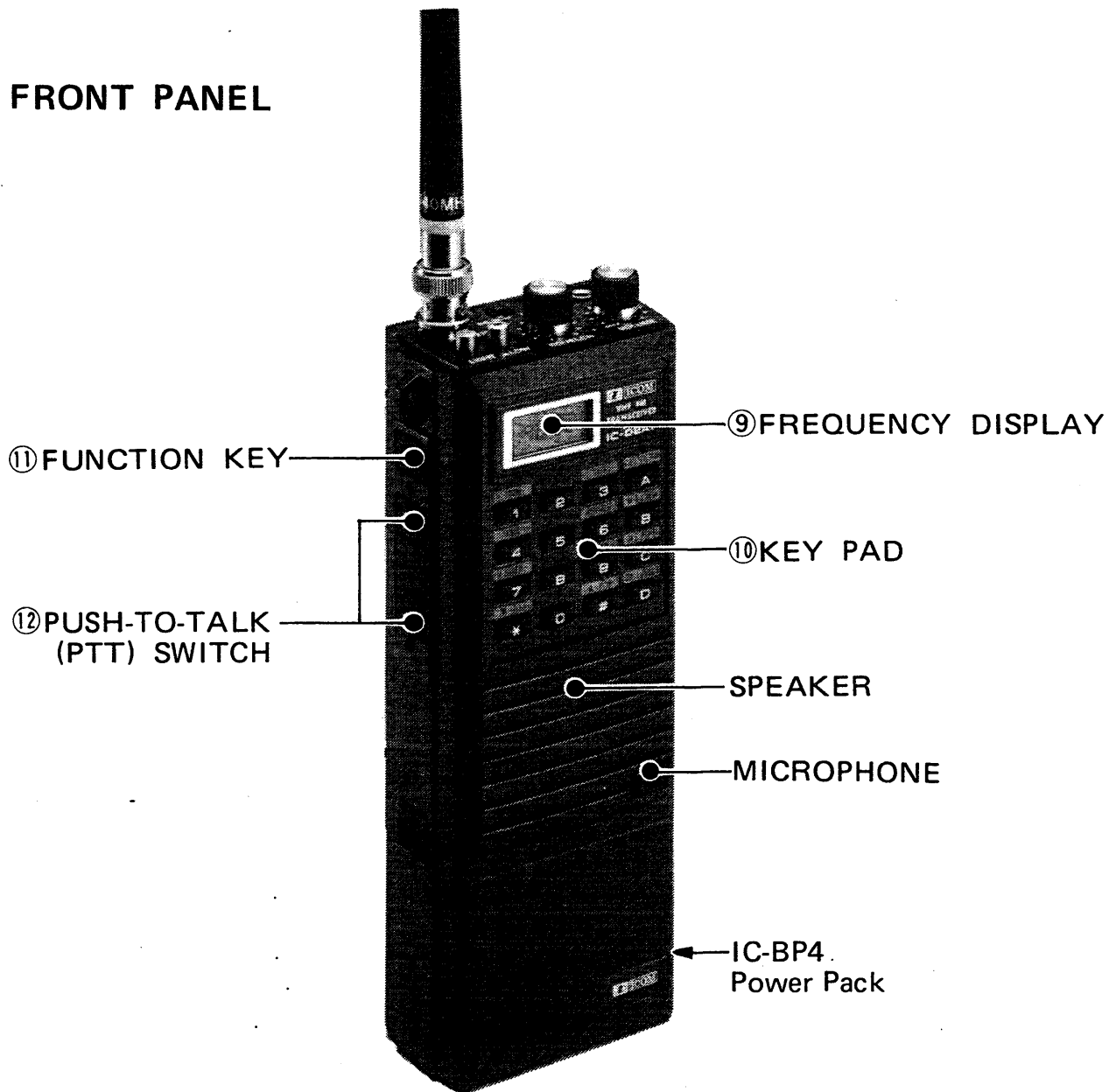

REAR PANEL

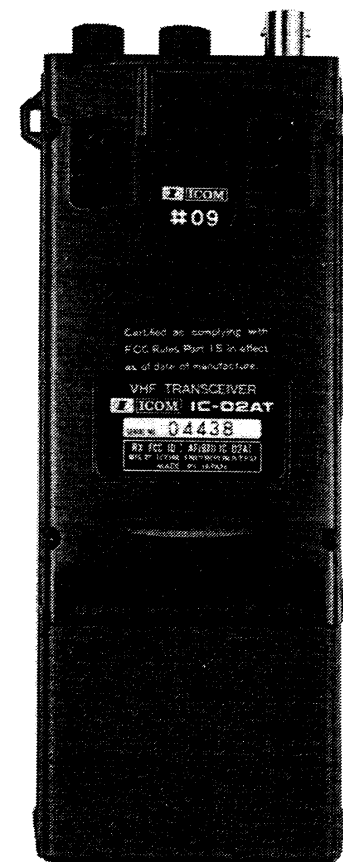

① ANTENNA CONNECTOR

Connect the supplied flexible antenna. An external antenna can be used using a BNC connector.

② EXTERNAL DC POWER JACK

A voltage regulated DC power supply with an output of 12 volts ~ 15 volts can be connected here, instead of using the attached battery pack. Inserting the power plug into this jack, disables the attached power pack.

③ EXTERNAL MIC JACK

When an external microphone is used, connect it to this jack. See the schematics for the proper hookup. When the external microphone is connected, the built-in microphone does not function. The optional speaker-microphone, IC-HM9 and headset HS-10 with VOX unit, HS-10SA or PTT switchbox, HS-10SB can also be used.

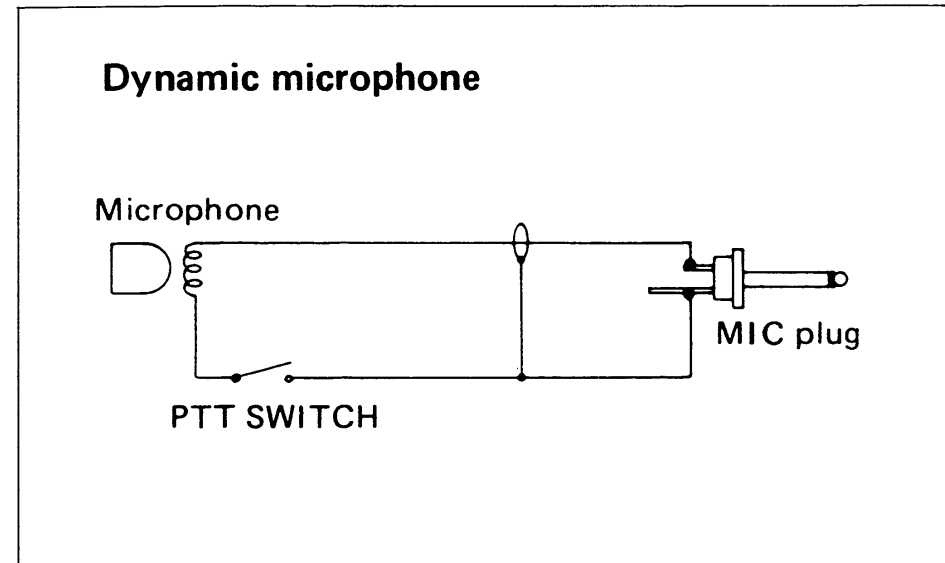
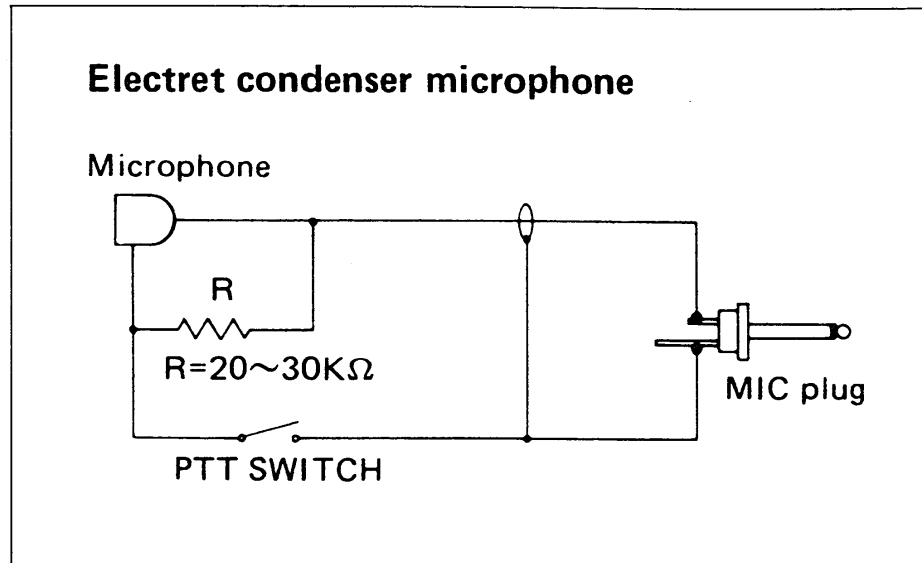

④ EXTERNAL SPEAKER JACK

When an external speaker (or an earphone) is used, connect it to this jack. Use a speaker with an impedance of 8 ohms. When the external speaker is connected, the built-in speaker does not function.

⑤ VOLUME CONTROL and POWER SWITCH

When this control is turned completely counterclockwise, the power is OFF. By turning the control clockwise beyond the "click", the unit is turned ON and the audio level increases as the control is rotated further clockwise.

⑥ SQUELCH CONTROL

Sets the squelch threshold level. To turn OFF the squelch function, rotate this control completely counterclockwise. To set the threshold level higher, rotate the control clockwise.

⑦ LIGHT SWITCH

When this switch is down in the locked position, the frequency display is lit for easier viewing in the dark. When using a battery power pack to power the IC-02A/AT, keep this switch in the out position to save power.

⑧ RF POWER SWITCH

Switches the output power of the set between HIGH and LOW.

- LOW (locked in) : 0.5W with any ICOM battery pack
- HIGH (out) : 3.5W with IC-BP4 (9V)

⑨ FREQUENCY DISPLAY

Indicates not only the operating frequency but also several other functions as follows:

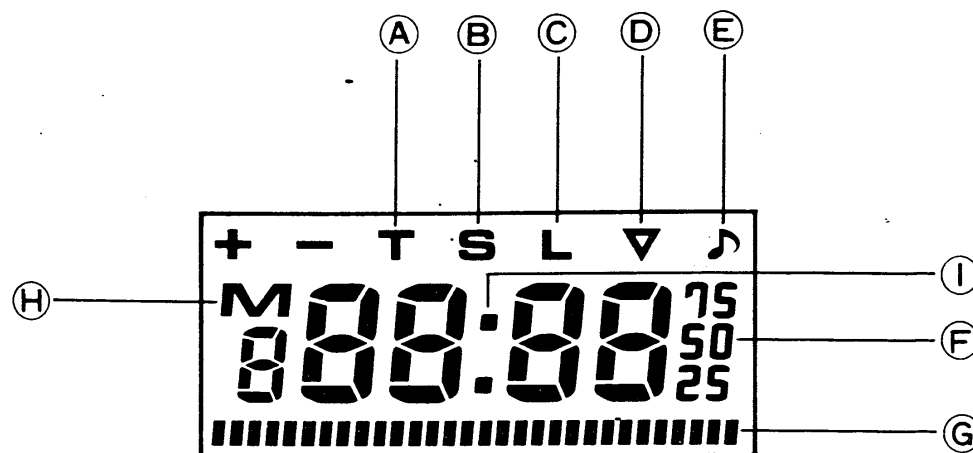

① TRANSMIT INDICATOR

"T" is indicated when the set is in the transmit mode.

② SCAN INDICATOR

"S" is indicated when the set is in a scan mode.

③ LOCK INDICATOR

"L" is indicated when the operating frequency is locked by pushing the "D" key while the "FUNC" key is depressed. At this time, any key entries will be cancelled, except "FUNC" and "D" (LOCK) keys when used to clear the lock function.

④ BATTERY CONDITION INDICATOR

"▽" is indicated just before the battery is exhausted in the transmit mode. When the "▽" is indicated stop using the set and recharge the battery pack or replace the battery pack with a charged one.

Ⓔ TONE ENCODER INDICATOR

“T” is indicated when the subaudible audio tone encoder is actuated by pushing “1” (TONE) key while the “FUNC” key is depressed. (IC-02AT only)

Ⓕ FREQUENCY DISPLAY

Indicates the operating frequency with 5 digits representing 100MHz through 10kHz. The small “50” represents 5.0kHz. In the memory channel mode, the 100MHz digit shows the memory channel number.

Ⓖ S/R F INDICATOR

Indicates signal strength and RF output level with a dotted bar. The RF output level meter functions only as a relative output meter and does not indicate the power. These functions are switched automatically while changing between transmit and receive.

Ⓗ MEMORY MODE INDICATOR

“M” is indicated when the set is in the memory mode and while memory writing.

Ⓘ PRIORITY FUNCTION INDICATOR

“P” is indicated when the set is in the priority function.

⑩ KEY PAD

This key pad has 16 keys consisting of ten numerical keys and six code keys. Most keys have dual functions.

The primary functions are available by just pushing each key. The ten numerical keys input the digit indicated on each key. The other keys function to activate functions indicated above each key with letters on a gray colored background.

The secondary functions are available by pushing each key while the "FUNC" key on the side is depressed. Each function is indicated above the key with letters on an olive colored background.

⑪ FUNCTION KEY

By depressing this key, the secondary function of each key can be selected.

**⑫ PUSH-TO-TALK (PTT)
SWITCH**

For transmission, press this switch and talk into the microphone in a normal voice. The internal microphone is an electret condenser that provides good pickup for all voice levels.

SECTION 6 OPERATION

6 - 1 RECEIVING

① Set the controls and switches.

② Turn the VOLUME CONTROL and POWER SWITCH on.

③ Adjust SQUELCH CONTROL.

① Set the controls and switches as follows:

| SWITCH/CONTROL | POSITION |
|-----------------|-----------------------------|
| POWER SWITCH | OFF |
| SQUELCH CONTROL | Completely counterclockwise |
| LIGHT SWITCH | OFF (out) |

② Turn the VOLUME CONTROL and POWER SWITCH clockwise past the "click". A frequency will be shown on the FREQUENCY DISPLAY. Slowly turn the VOLUME CONTROL clockwise to a comfortable level. Set the desired frequency by pushing keys. When a signal is received, the S/RF INDICATOR will show its signal strength.

③ If only noise is heard, turn the SQUELCH CONTROL clockwise until the noise from the speaker just stops. The transceiver will now remain silent until an incoming signal is received which opens the squelch. If the squelch is unstable due to the reception of weak signals or mobile stations, adjust the squelch control further until the proper threshold is obtained.

6 - 2 TRANSMITTING

- ① For SIMPLEX operation, make sure neither “+” nor “-” is displayed.
 - ② For DUPLEX operation, set the repeater’s input/output frequencies.
 - ③ Select the output power.
 - ④ Push the PTT switch to transmit.
 - ⑤ Speak into the microphone.
 - ⑥ Release the PTT switch to return to the receive mode.
- ① For SIMPLEX operation, make sure neither “+” nor “-” is displayed on the frequency display. If “+” or “-” is displayed, the set is in the DUPLEX mode. See page 28 to change to the SIMPLEX mode.
 - ② For DUPLEX operation, set the frequency separation according to the repeater’s input/output frequencies.
 - ③ If the lower output power (0.5 watts) is sufficient, push the RF POWER SWITCH in.
 - ④ Push the PTT (Push-To-Talk) switch on the side and the transceiver will transmit. At the same time, the letter “T” is displayed above the 1MHz digit on the frequency display and the S/RF INDICATOR will provide an indication of relative power output of the transmitter.
 - ⑤ Speak into the microphone with your normal speech level.
 - ⑥ To return to the receive mode, release the PTT switch.

If you need a subaudible tone to access a repeater, set the tone number suitable for the repeater (IC-02AT only). Refer to “SETTING TONE ENCODER FREQUENCY” on page 24.

If you need DTMF tones (the same tones as telephone dialing tones) to access a repeater or to make an auto phone-patch, push a digit key while depressing the PTT switch, then continue to push digit keys without depressing the PTT switch. After pushing a digit key, the transmit mode is maintained for about one second. (IC-02AT only).

● UNLOCKED PLL

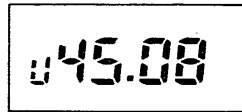

Dial mode

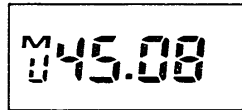











Memory mode







NOTE: When the PLL (Phase-Locked Loop) in the transceiver becomes unlocked, the display appears as shown at the left. Note the small "U" which stands for "unlocked". At this time, the transmitter is muted and no signals are transmitted. This unlocked condition may be caused by an exhausted battery, so check your power pack first.

6 - 3 KEY FUNCTIONS

Some keys have dual functions. To select the secondary function, push the "FUNC" key located on the side of the transceiver, and then push the correct key for the function you desire.

| PRIMARY FUNCTION | | SECONDARY FUNCTION | |
|------------------|----------------------|---|--|
| KEY | FUNCTION | KEY | FUNCTION |
| 1 | Sets the digit of 1. | <div style="border: 1px solid black; padding: 2px; display: inline-block;">TONE</div> <div style="border: 1px solid black; padding: 2px; display: inline-block;">1</div> | <p>Sets a desired subaudible tone or turns the tone ON/OFF.</p> <p>Push this key then desired tone number keys. To turn off the function, push this key again.</p> |
| 2 | Sets the digit of 2. | ----- | ----- |
| 3 | Sets the digit of 3. | <div style="border: 1px solid black; padding: 2px; display: inline-block;">STEP</div> <div style="border: 1px solid black; padding: 2px; display: inline-block;">3</div> | <p>Sets a desired frequency step.</p> <p>Push this key, then one of the step keys "1" ~ "5".</p> |
| 4 | Sets the digit of 4. | <div style="border: 1px solid black; padding: 2px; display: inline-block;">PRIO</div> <div style="border: 1px solid black; padding: 2px; display: inline-block;">4</div> (PRIORITY) | <p>Sets the priority function.</p> <p>To turn off this function, push the "A" key without depressing the "FUNC" key.</p> |
| 5 | Sets the digit of 5. | ----- | ----- |
| 6 | Sets the digit of 6. | <div style="border: 1px solid black; padding: 2px; display: inline-block;">REVERSE</div> <div style="border: 1px solid black; padding: 2px; display: inline-block;">6</div> | <p>In the duplex mode, the transmit and receive frequencies are exchanged with each other.</p> |

| PRIMARY FUNCTION | | SECONDARY FUNCTION | |
|---|--|---|--|
| KEY | FUNCTION | KEY | FUNCTION |
|  | Sets the digit of 7. |  | Sets a desired receive/transmit frequency separation. Push this key, then the desired separation frequency using four digits. |
|  | Sets the digit of 8. | ----- | ----- |
|  | Sets the digit of 9. |  | Turns on and off the beep tone circuit which generates a tone when a key is pushed. |
|  | Sets the digit of 0. | ----- | ----- |
|  | Decreases the operating frequency with specified steps, or operating memory channel number. |  | Sets the “-” duplex mode. Push the key again to change to the simplex mode. |
|  | Increases the operating frequency with specified steps, or operating memory channel number. |  | Sets the “+” duplex mode. Push the key again to change to the simplex mode. |
|  | Clears the entered number, and recalls previous frequency or clears previous number to “00”. Clears the memory channel mode and selects the DIAL mode. Clears the priority function. Clears any scan function and the operating frequency or memory channel stops on the displayed one. | ----- | ----- |

| PRIMARY FUNCTION | | SECONDARY FUNCTION | |
|--|--|---|--|
| KEY | FUNCTION | KEY | FUNCTION |
| MR  | Sets the radio in the memory channel mode. Push the key, then a desired channel number "0" ~ "9". | MR/MW  | Writes the displayed frequency into a memory channel. Push the key, then a desired channel number to store the displayed frequency. |
| MS  | Sets the radio in the memory scan mode. Scans all memories. | MS/PS  | Sets the radio in the programmed scan mode. Scans between the frequencies memorized in channel 5 and channel 6 with specified steps. |
| CALL  | Selects the frequency memorized in MEMORY CHANNEL 3. At this time, any key entries are cancelled except the "A" key to clear this function. | CALL/LOCK  | Cancels any key entries to prevent accidental key operation. To clear this function, push this key again while depressing the "FUNC" key. |

6 - 4 DIAL MODE

(1) SETTING FREQUENCY

- ① To set an operating frequency, push four digit keys representing the frequency desired, beginning with the MHz and ending with the kHz digit.

- ② If illegal digits or an out-of-band frequency have been entered, the entered ones are cancelled and the previous operating frequency will be recalled.
- ③ When a wrong key has been pushed, push the "A" (CL) key. The entered digits are cancelled and the previous operating frequency will be recalled.

The last digit key pushed enters the following frequency.

| KEY | 1 | 2 | 3 | 4 | 5 | 6 | 7 | 8 | 9 | 0 | UNIT |
|---------|---|---|---|---|---|---|---|---|---|---|------|
| IC-02A | — | — | — | — | 5 | — | — | — | — | 0 | kHz |
| IC-02AT | — | — | — | — | 5 | — | — | — | — | 0 | kHz |

NOTE: A "—" indicates the key entry is cancelled, and the previous operating frequency is recalled.

●When setting 145.68MHz:

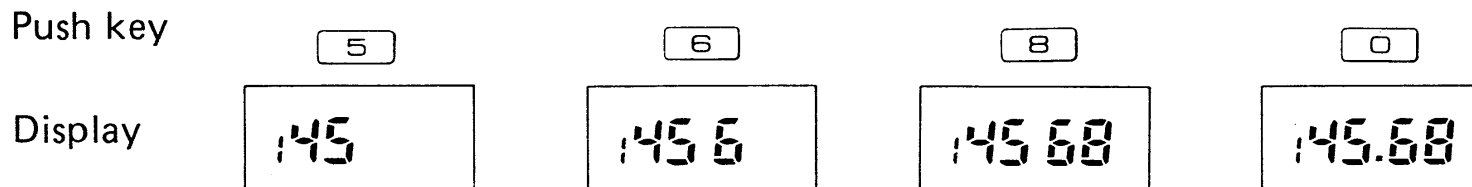

●When setting 145.6850MHz:

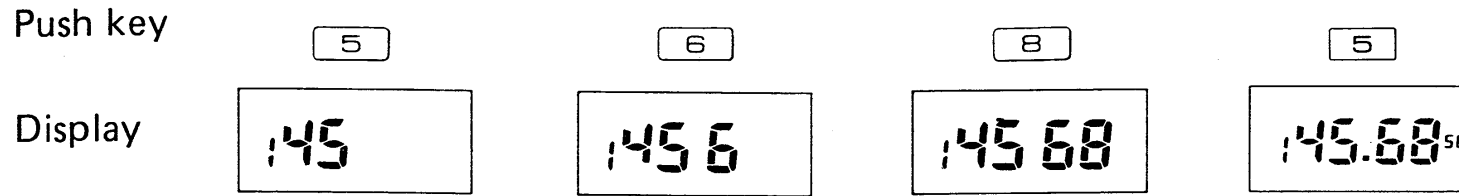

The duplex frequency separation and tone encoder frequency which have been set before (if any), will be kept.

④ With each push of the “#” (▲) or “*” (▼) key, the operating frequency will be changed one increment up or down with the specified frequency step rate (described later) respectively. In the same way, holding the key down, shifts the operating frequency up or down continuously.

●When the frequency step rate is set at 5kHz:
(See page 25 for setting the frequency step rate.)

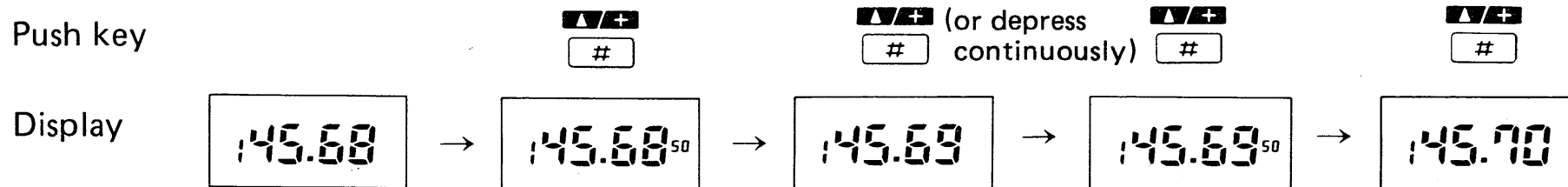

●When the frequency step rate is set at 12.5kHz:

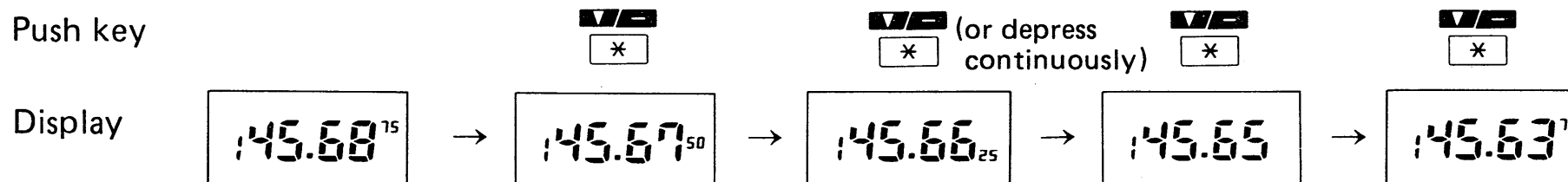

(2) SETTING TONE ENCODER FREQUENCY (IC-02AT only)

① To set the tone encoder frequency, while pushing the "FUNC" key, push the "1" (TONE) key then the two digit keys for the tone number.

② If an illegal number (a number that is not shown in the table) has been entered, the number is cancelled and the previous number will be recalled.

③ To turn off the tone encoder, push the "1" (TONE) key while the "FUNC" key is pushed.

The tone frequency for each number is shown on the next page.

●When setting the tone frequency for 79.7Hz:

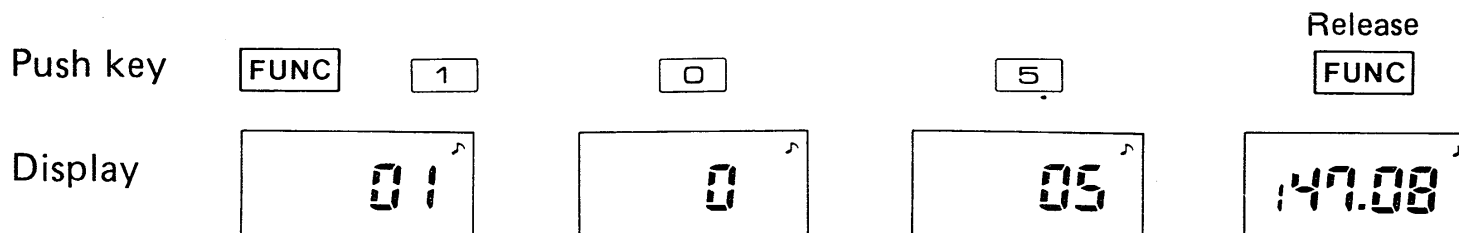

●To turn the tone ON/OFF:

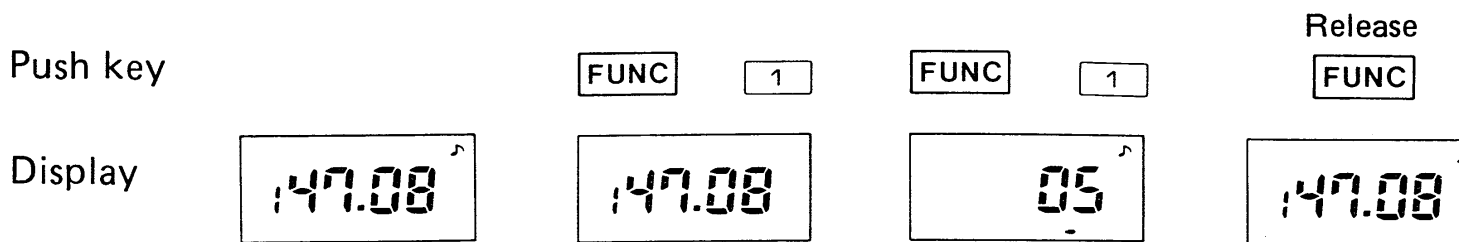

The tone frequency for each number is shown in the following table.

| TONE NO. | FREQUENCY (Hz) | TONE NO. | FREQUENCY (Hz) | TONE NO. | FREQUENCY (Hz) |
|----------|----------------|----------|----------------|----------|----------------|
| 01 | 67.0 | 16 | 114.8 | 31 | 192.8 |
| 02 | 71.9 | 17 | 118.8 | 32 | 203.5 |
| 03 | 74.4 | 18 | 123.0 | 33 | 210.7 |
| 04 | 77.0 | 19 | 127.3 | 34 | 218.1 |
| 05 | 79.7 | 20 | 131.8 | 35 | 225.7 |
| 06 | 82.5 | 21 | 136.8 | 36 | 233.6 |
| 07 | 85.4 | 22 | 141.3 | 37 | 241.8 |
| 08 | 88.5 | 23 | 146.2 | 38 | 250.3 |
| 09 | 91.5 | 24 | 151.4 | | |
| 10 | 94.8 | 25 | 156.7 | | |
| 11 | 97.4 | 26 | 162.3 | | |
| 12 | 100.0 | 27 | 167.9 | | |
| 13 | 103.5 | 28 | 173.8 | | |
| 14 | 107.2 | 29 | 179.9 | | |
| 15 | 110.9 | 30 | 186.2 | | |

(3) SETTING FREQUENCY STEP RATE

- ① To set the frequency step rate, push and hold the "FUNC" key, "3" (STEP) key and then push a key to determine the step rate.
- ② If an illegal number has been entered, the number is cancelled and the previous rate number will be recalled.

③ The frequency step rate allocated to each key is shown in the following chart.

| KEY/DISPLAY | 1 | 2 | 3 | 4 | 5 | 6 | 7 | 8 | 9 | 0 | UNIT |
|-------------|-----|------|------|------|------|---|---|---|---|---|------|
| IC-02A | 5.0 | 10.0 | 15.0 | 20.0 | 25.0 | — | — | — | — | — | kHz |
| IC-02AT | 5.0 | 10.0 | 15.0 | 20.0 | 25.0 | — | — | — | — | — | kHz |

NOTE: A “—” indicates the key entry is cancelled, and the previous operating frequency is recalled.

●When setting 20kHz:

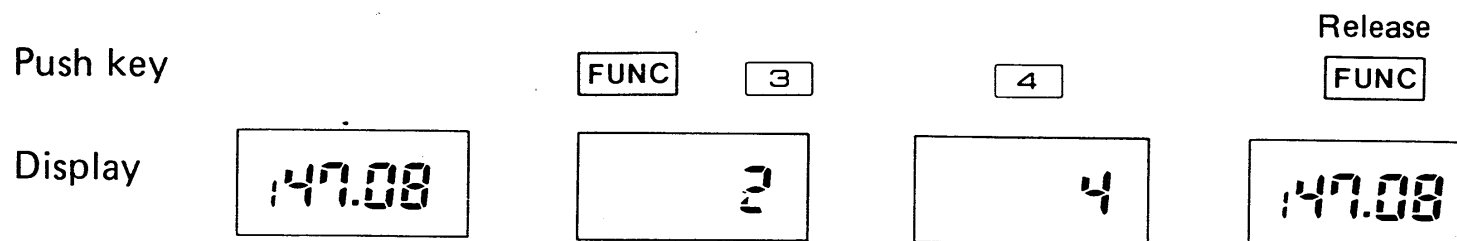

●When setting 25kHz:

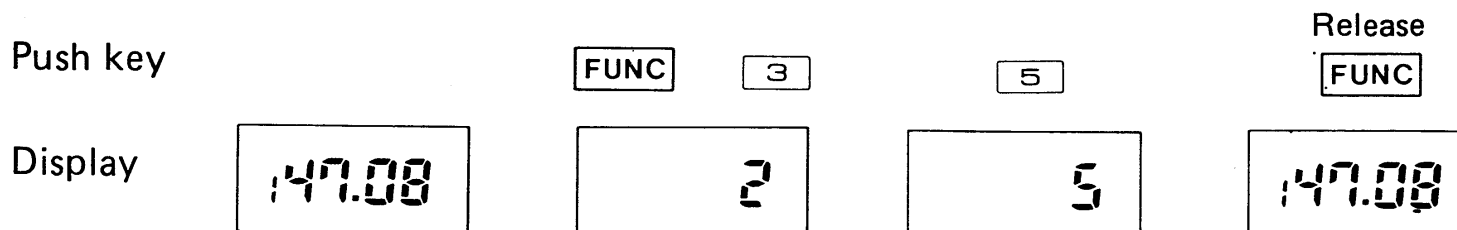

(4) SETTING DUPLEX FREQUENCY SEPARATION

- ① While pushing the "FUNC" key, push the "7" (SHIFT) key, then the four digit keys (MHz to kHz digits) of the desired frequency separation.
- ② If illegal digits have been entered, the entered ones are cancelled and the previous frequency separation will be recalled.
- ③ The last digit entered has some limitations, the same as "SETTING FREQUENCY" on page 21.

●When setting the frequency separation for +600kHz/+0.60MHz:

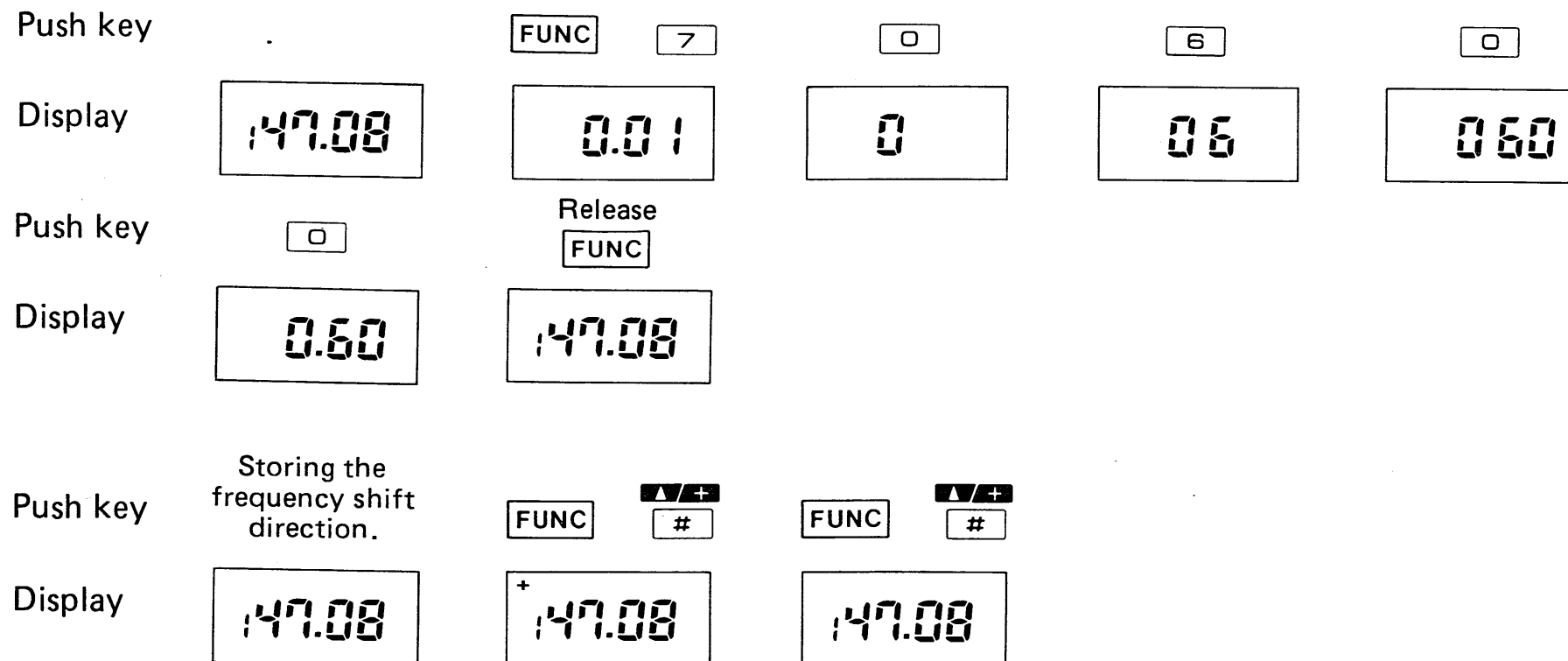

- ④ To change the duplex direction (+duplex to -duplex or vice versa) with the previous frequency separation, while pushing the "FUNC" key, push the "*" (-) or the "#" (+) key for the new direction desired.
- ⑤ To change the duplex mode to simplex mode, push the "FUNC" key and the "*" (-) or "#" (+) key with the same symbol (+ or -) as appears on the display.

●When changing the duplex direction:

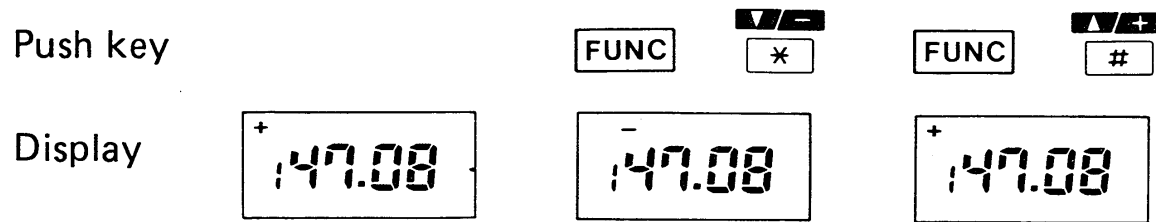

(5) MEMORY WRITING

- ① To memorize a frequency, duplex mode, its frequency separation and tone number into a memory channel, set the desired frequency, duplex mode, etc., with the procedures described before. Then, while pushing the "FUNC" key, push the "B" (MEMORY WRITE) key, followed by a digit key which has the same number as the memory channel number.
- ② The radio has 10 memory channels, memory channel 1 ~ memory channel 0. Some are special channels as follows:

- **M1 (MEMORY CHANNEL "1")** The offset frequency for duplex operation in M1 will be the offset and tone applied to memory channels M2 ~ M6. That is, memory channels 1 ~ 6 will have the same offset and tone entered in M1.
- **M3** The frequency memorized in M3 can be recalled by just pushing the "D" (CALL) key.
- **M4** The frequency memorized in M4 will be the priority frequency on priority scanning. The priority scan is described on page 32.
- **M5 and M6** The frequencies memorized in M5 and M6 will be the limits of the programmed scanning range. Regardless of which channel the higher frequency is memorized in, the scan starts from the frequency memorized in memory channel 5.
- **M7 ~ M0** The offset frequency and tone number can be memorized into each memory channel independently.

● **When memorizing 145.68MHz into memory channel 7 (M7):**

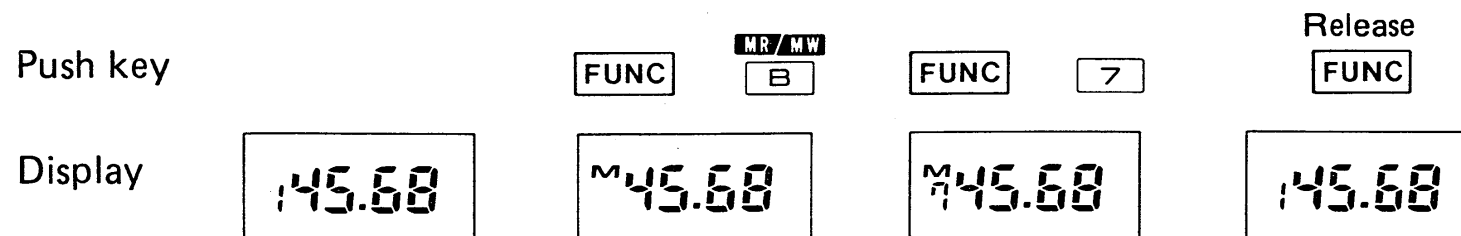

(6) TURNING THE BEEP TONE ON/OFF

Each push of the "9" (BEEP) key while depressing the "FUNC" key turns the beep tone ON and OFF alternately. When the tone is ON the beep sounds each time a key is pushed. The volume of the beep tone can be adjusted by turning the VOLUME control the same as the receiver audio volume control.

(7) STARTING THE PROGRAMMED SCAN FUNCTION

By pushing the "C" (PS) key while depressing the "FUNC" key, the programmed scan is started. The programmed scan scans between the frequencies memorized in memory channels 5 and 6. More detail is described later.

6 - 5 MEMORY CHANNEL MODE

(1) MEMORY READ

To recall a frequency memorized in a memory channel, push the "B" (MR) key then a digit key of the same number as the memory channel which contains the desired frequency. The duplex mode and/or tone number (IC-02AT only) also can be recalled at the same time if they have been memorized.

●When recalling the frequency memorized in memory channel 7:

Push key

(In DIAL MODE)

MR/MW
B

7

Display

45.68

M 45.68

+
M 45.46

- ① After this, the other memory channels can be recalled by just pushing the digit key of the memory channel number.

●When changing memory channel:

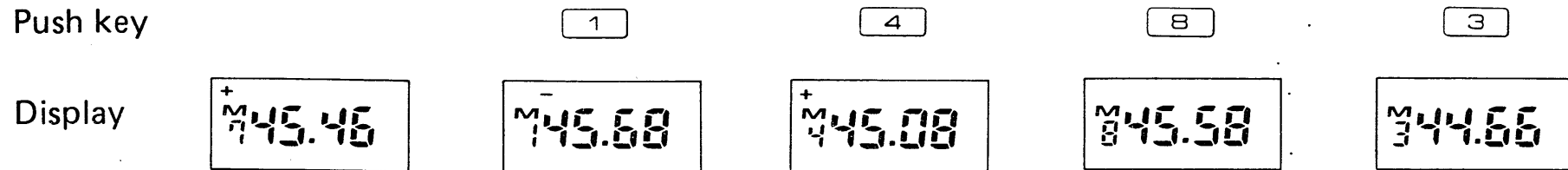

●When changing memory channel by using UP/DOWN key:

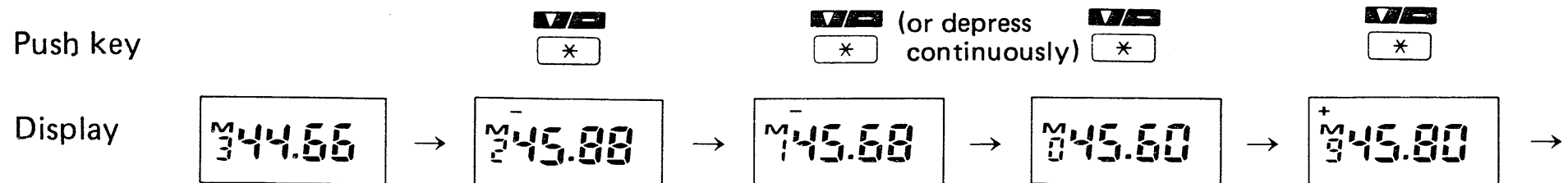

NOTE: In the MEMORY CHANNEL MODE, all secondary functions except the PRIORITY and LOCK functions are disabled.

- ② Pushing or holding down the “#” (UP) key or the “*” (DOWN) key, changes the memory channel number in order, and displays the channel number and contents of each memory channel on the frequency display.
- ③ By pushing the “A” (CL) key, the MEMORY CHANNEL MODE is cleared and the set returns to the DIAL MODE.

(2) CALL KEY

- ① When the set is in either MEMORY CHANNEL MODE or DIAL MODE, pushing the "D" (CALL) key recalls the frequency memorized in memory channel 3 (M3). The letter "C" appears which indicates the CALL function is activated.
- ② At this time, all key functions except the CLEAR and LOCK functions are disabled.
- ③ To clear the CALL KEY function, just push the "A" (CL) key and the frequency and memory channel number (if in the MEMORY CHANNEL MODE) previously displayed are recalled on the frequency display.

●When recalling CALL channel memorized in M3:

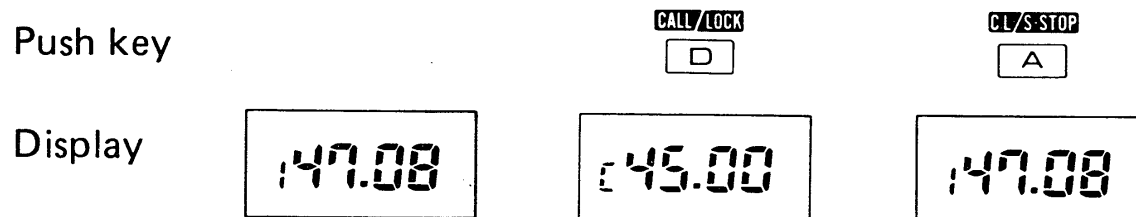

6 - 6 PRIORITY FUNCTION

This feature allows you to check on your favorite frequency, such as a local repeater or calling channel, for activity while operating on a dial frequency or memory channel. It allows you to check if the frequency is busy or empty.

The following steps are taken to utilize the PRIORITY FUNCTION.

- ① Memorize your favorite frequency into memory channel 4.
- ② Set the desired operating frequency by pushing keys or select a memory channel which has the desired operating frequency memorized.
- ③ Push the "4" (PRIO) key while pushing the "FUNC" key, and the set receives on the operating frequency a period of five seconds and on the priority channel (memory channel which contains your favorite frequency) one second. This action repeats until the PRIORITY FUNCTION is cleared. At this time, a dot is indicated above the decimal point to show the set is in the PRIORITY FUNCTION.
- ④ In the PRIORITY FUNCTION, all key functions except the "A" (CL) key function are disabled.
- ⑤ If the set is placed in the transmit mode during the priority function, the transmit frequency will be the operating frequency in the SIMPLEX mode, or its associated transmit frequency in the DUPLEX mode. When returned to the receive mode, the priority function will be continued.

⑥ To clear the PRIORITY FUNCTION, just push the "A" (CL) key.

● When the contents of M4 are 145.68MHz and -600kHz duplex, and the desired operating frequency is 145.52MHz with -600kHz duplex:

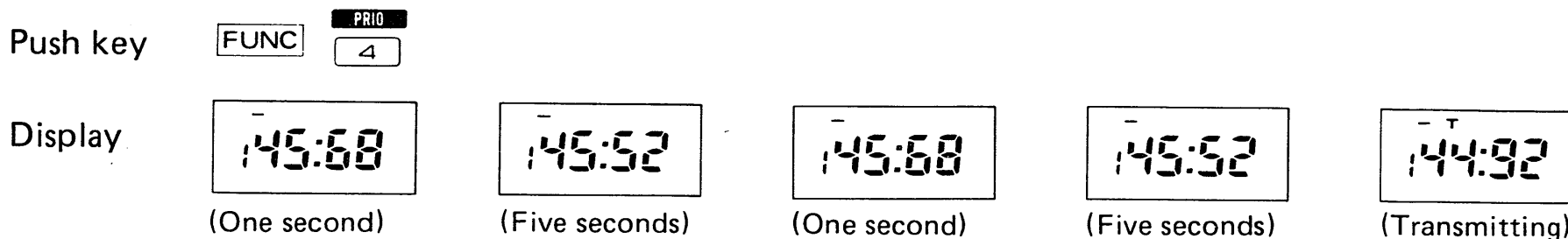

6 - 7 LOCK FUNCTION

This function prevents accidental frequency and function changes. It operates both in the DIAL and MEMORY CHANNEL MODES.

By pushing the "D" (LOCK) key while depressing the "FUNC" key, the displayed frequency (and other data, if any) is fixed, and the letter "L" is displayed above the 100kHz digit to show the LOCK FUNCTION is actuated. At this time, all key functions are disabled.

To clear the LOCK function, push the "D" (LOCK) key again while depressing the "FUNC" key.

6 - 8 SCANNING OPERATIONS

The IC-02A/AT provides MEMORY SCAN and PROGRAMMED SCAN operation.

(1) MEMORY SCAN

This is to continuously scan all ten memory channels in order.

- ① Memorize ten desired frequencies into memory channels 1 ~ 0. If your desired frequencies number less than ten, we recommend you memorize the same frequency into several memory channels.
- ② To start the scan, just push the "C" (MS) key, and the letter "S" is displayed above the 1MHz digit on the frequency display and the scan starts.
- ③ If the SQUELCH is engaged, the scan stops when the squelch is opened and a signal is received. The scan will resume after the signal goes away.
- ④ To resume the scan when the scan stops on a signal, push the "C" (MS) key, and the displayed memory channel changes to the next higher channel. If this channel has no signal, the scan will resume.
- ⑤ If the set is placed in the transmit mode during the scan function, the transmit frequency will be the frequency (memory channel) displayed on the frequency display at the moment. At this time, the scan function is cleared and the frequency (memory channel) is locked.

- ⑥ To clear the scan function, push the "A" (CL) key, and the scan stops on the memory channel displayed and the letter "S" on the frequency display goes out.
- ⑦ When the set is in this scan mode, all key functions, except the "A" (CL) key and the "C" (MS) key functions, are disabled.

●When operating the MEMORY SCAN:

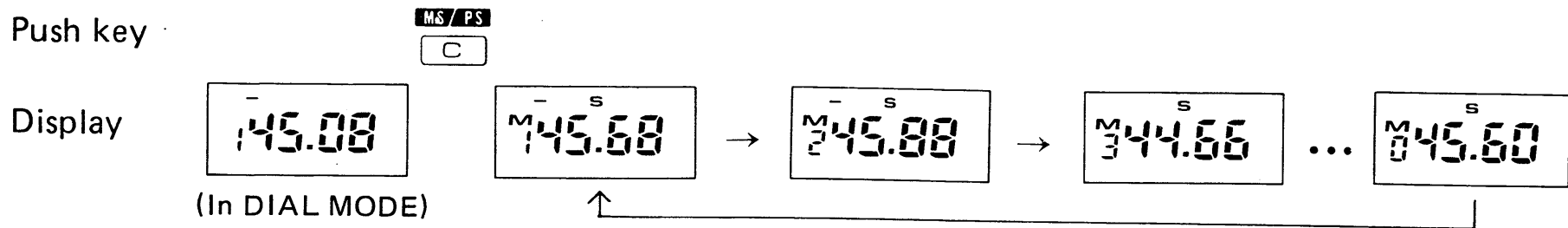

(2) PROGRAMMED SCAN

This is used to scan between two desired frequencies, which are memorized in the memory channels 5 and 6.

- ① Store the frequencies of the limits of the desired scanning range into memory channels 5 and 6. Regardless of which channel the high edge frequency is memorized in, the scan starts from the frequency memorized in the memory channel 5. If the same frequency is memorized in both memory channels 5 and 6, the scan will not start.

- ② Set the IC-02A/AT in the DIAL MODE. The PROGRAMMED SCAN will not start from the MEMORY CHANNEL MODE.
- ③ Push the "C" (PS) key while depressing the "FUNC" key, and the scan starts from the frequency memorized in memory channel 5 and moves towards the frequency memorized in channel 6. The scanning frequency increments depend on the frequency step rate setting.
- ④ When the scanning frequency reaches the frequency memorized in memory channel 6, it automatically returns to the frequency memorized in memory channel 5 and continues scanning to provide endless scanning operation.
- ⑤ Any signal which opens the SQUELCH when it is engaged stops the scan automatically and the transceiver locks onto the frequency.
- ⑥ To resume the scan when the scan stops on a signal, push the "C" (MS) key and the displayed frequency changes one increment. If the new frequency is vacant, the scan will resume.
- ⑦ If the set is placed in the transmit mode during the scan function, the transmit frequency will be the frequency which appears on the frequency display at the moment. At this time, the scan function is cleared and the frequency is locked.

⑧ To clear the scan function, push the "A" (CL) key, and the scan stops on the frequency displayed and the letter "S" on the frequency display goes out.

⑨ When the set is in this scan mode, all key functions except the "A" (CL) key and the "C" (PS) key are disabled.

● When 145.600MHz is memorized in memory channel 5 and 145.800MHz in memory channel 6, and the frequency step rate is set at 25kHz.

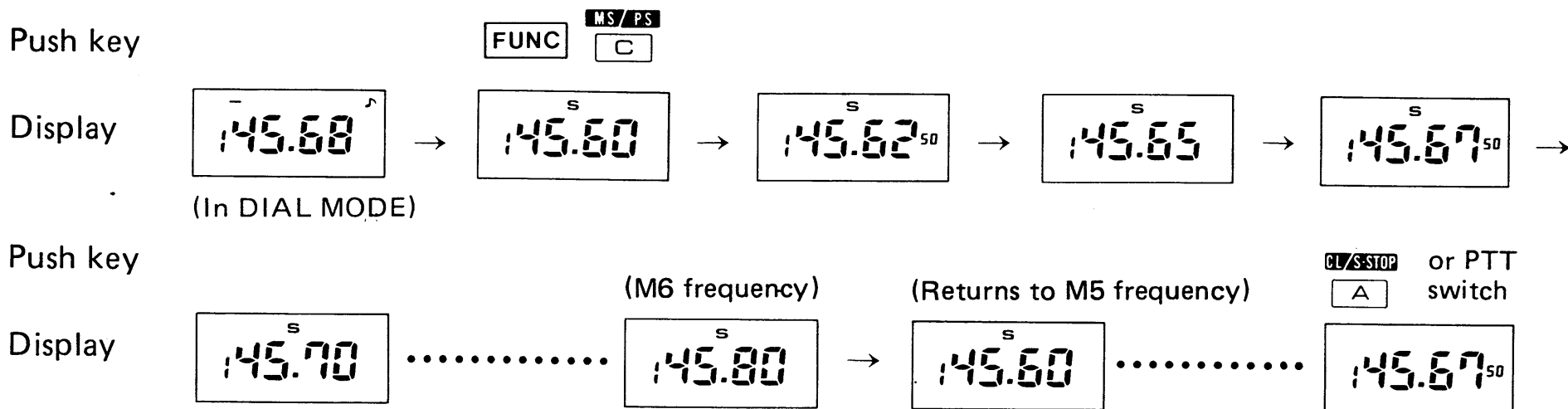

SECTION 7 INSIDE VIEWS

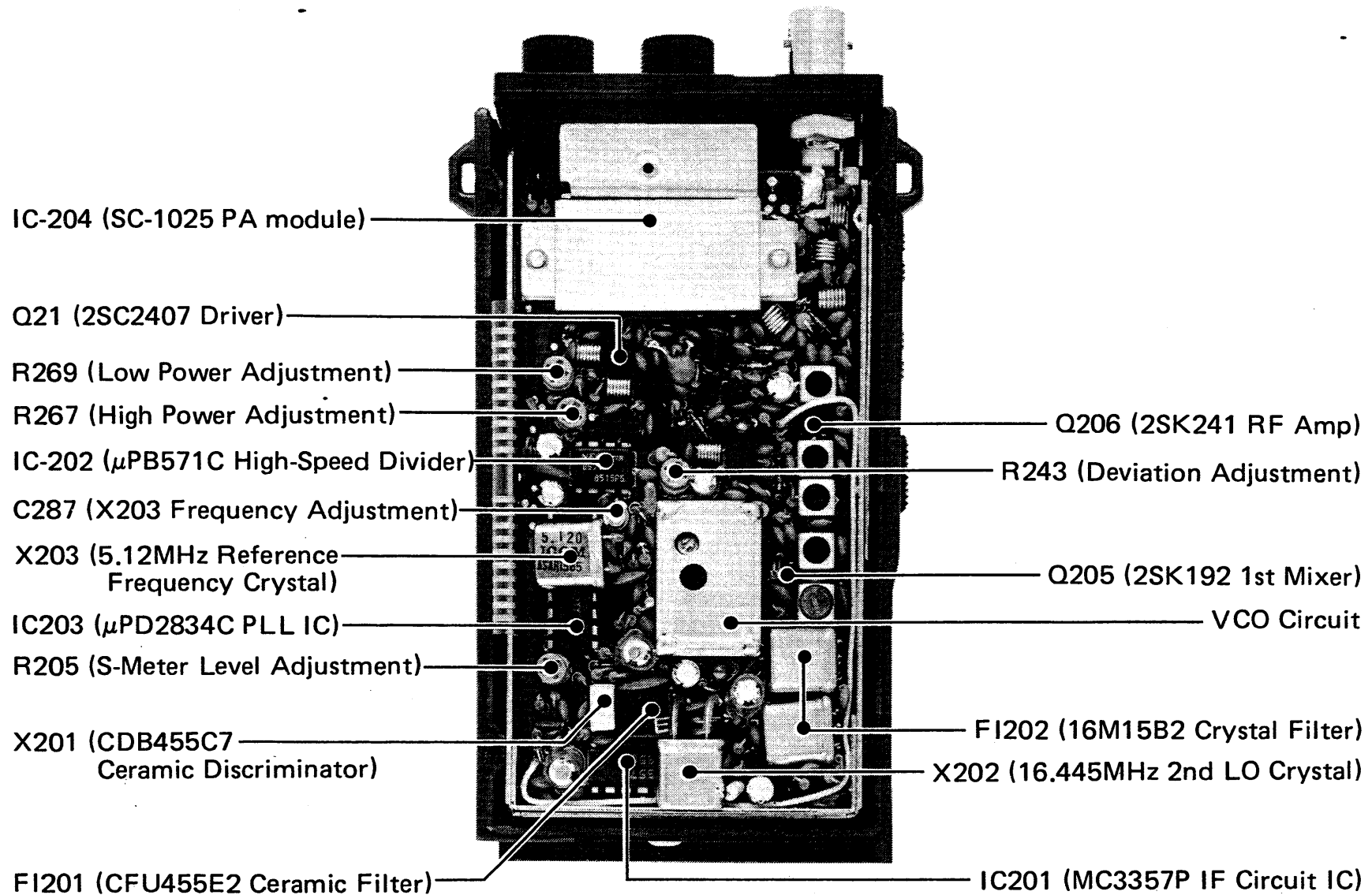

R510 (Subaudible
Tone Level Adj.)

R507 (DTMF
Level Adj.)

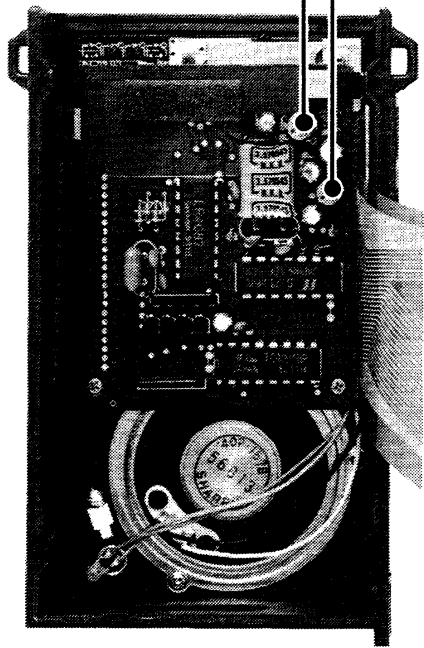

IC-02AT
(with the DTMF unit)

IC401
(HD 44795 CPU)

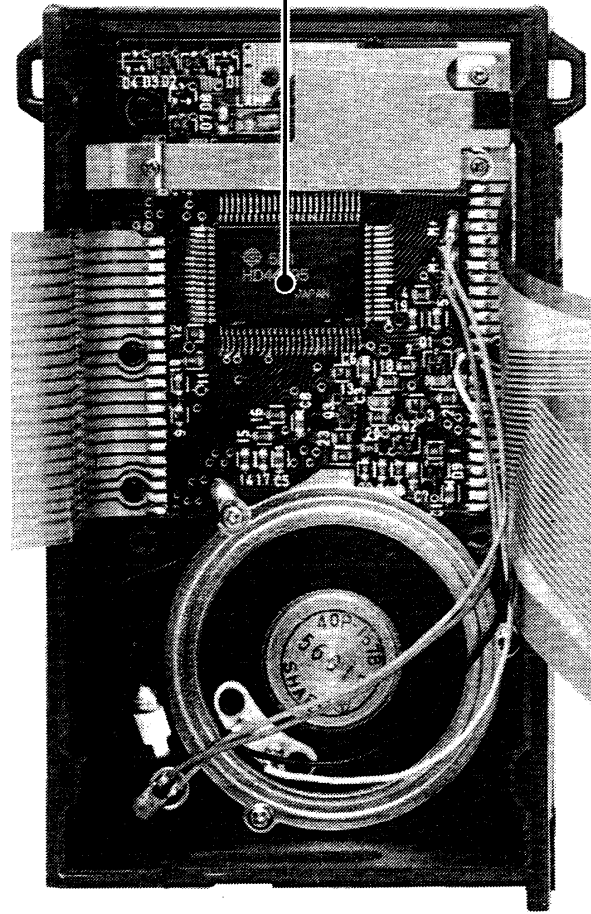

(When the DTMF unit is
removed.)

RL101 (Power Source
Switching Relay)

R132 (Volume Control
and Power Switch)

R126 (Squelch Control)

IC101 (TA75358P AF
Low-Pass Filter)

IC105 (TA75393P Battery
Exhausted Detect)

IC102 (4071 T/R Control)

IC103 (4069 Beep Osc.
Squelch Control)

BT101 (Memory Backup
Battery)

Voltage Regulator Circuit

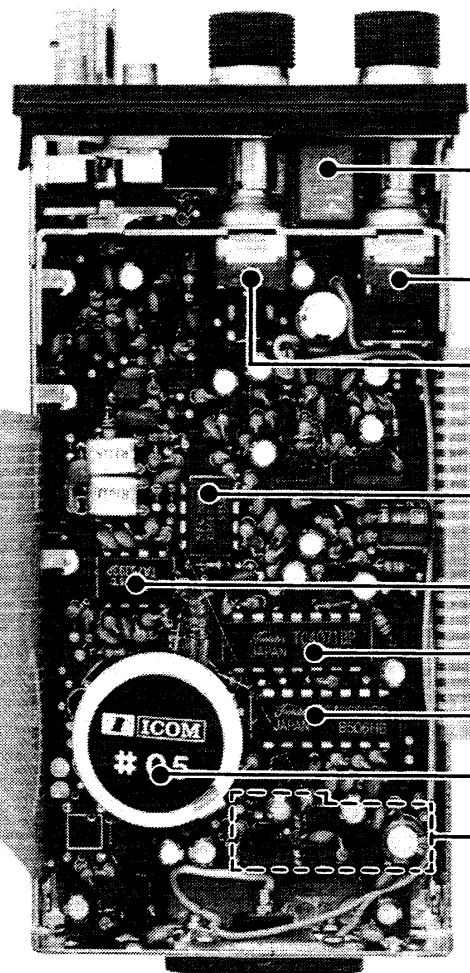

SECTION 8 TROUBLESHOOTING

Your IC-02A/AT has been tested very carefully at the factory before shipping. The chart below has been designed to help you correct any problems which are not equipment malfunctions. If you are not able to locate the problem and/or solve it through use of this chart, please contact your dealer or the nearest ICOM service center for assistance.

| Problem | Possible Cause | Solution |
|--|--|--|
| 1. Power does not come ON when the switch is turned. | Bad connection of the power pack. Reverse polarity of one or more batteries (when using IC-BP4). The battery is exhausted. | Check the connection of the power pack and correct any problems. Check the polarity of each battery and replace them into the pack. Replace the battery with a new one or recharge it. |
| 2. No sound comes from the speaker. | VOLUME CONTROL knob is completely counterclockwise. The unit is in the transmit mode, by the PTT switch. | Turn the knob clockwise to a suitable level. Put the unit in the receive mode. |

| Problem | Possible Cause | Solution |
|---|---|---|
| <p>2. No sound comes from the speaker. (Continued)</p> | <p>SQUELCH setting is turned too far clockwise.</p> <p>External speaker (or earphone) is in use.</p> <p>The battery is exhausted.</p> | <p>Turn the SQUELCH CONTROL counterclockwise until noise can be heard. Turn clockwise so the noise just disappears.</p> <p>Check if the external speaker plug is inserted properly or if the external speaker cable is cut.</p> <p>Replace the battery with a new one or recharge it.</p> |
| <p>3. Sensitivity is low and only strong signals are audible.</p> | <p>Bad connection of the flexible antenna.</p> <p>The antenna feedline is cut or shorted. (When using an external antenna.)</p> | <p>Check the connection of the antenna and correct any problems.</p> <p>Check the feedline and correct any improper condition.</p> |
| <p>4. No or low RF output.</p> | <p>RF Power switch is set at the Low position.</p> <p>The battery is exhausted.</p> <p>The antenna feedline is cut or shorted.</p> | <p>Set the RF Power switch to High position.</p> <p>Replace the battery with a new one or recharge it.</p> <p>Check the antenna feedline and correct any problems.</p> |

| Problem | Possible Cause | Solution |
|---|---|---|
| 5. No modulation. (When using external microphone.) | Bad connection of the MIC connector. | Check the connection of the MIC connector and correct any problems. |
| 6. The receive mode functions properly and your signals are transmitted, but you are unable to make a contact with another station. | <p>The set is in DUPLEX mode. (When desiring SIMPLEX mode.)</p> <p>The set is in SIMPLEX mode. (When desiring DUPLEX mode.)</p> <p>Improper frequency separation or input/output frequencies of the repeater.</p> | <p>Clear the DUPLEX mode by pushing “#” key, then “*” key in the DIAL mode.</p> <p>Set the proper frequency separation according to the repeater input/output frequencies.</p> <p>Set the proper frequency separation according to the repeater input/output frequencies.</p> |
| 7. The programmed scan does not function. | <p>The set is in the MEMORY CHANNEL mode.</p> <p>The frequencies memorized in M5 and M6 are the same, or their difference is less than the frequency step rate.</p> | <p>Push the “A” key to set in DIAL mode.</p> <p>Memorize frequencies with a difference of more than the frequency step rate into M5 and M6.</p> |
| 8. All key functions are disabled. | <p>The LOCK function is engaged.</p> <p>The CALL KEY function is engaged.</p> | <p>Clear the LOCK function by pushing the “D” key while depressing the “FUNC” key.</p> <p>Clear the CALL KEY function by pushing the “A” key.</p> |

BACKUP BATTERY

The IC-02A/AT uses an advanced, highly reliable CPU which is a complete, self-contained microprocessor. The purpose of the battery is to provide power to the CPU so it retains all memory information during power failures, or if the power pack is unplugged or turned off.

The usual life of the lithium battery is approximately five years of use. It is advisable to monitor the lithium battery carefully and replace it if there are repeated cases of display malfunction.

NOTE: Battery replacement should be done by your nearest ICOM Authorized Dealer or ICOM Service Center.

SECTION 9 BLOCK DIAGRAM

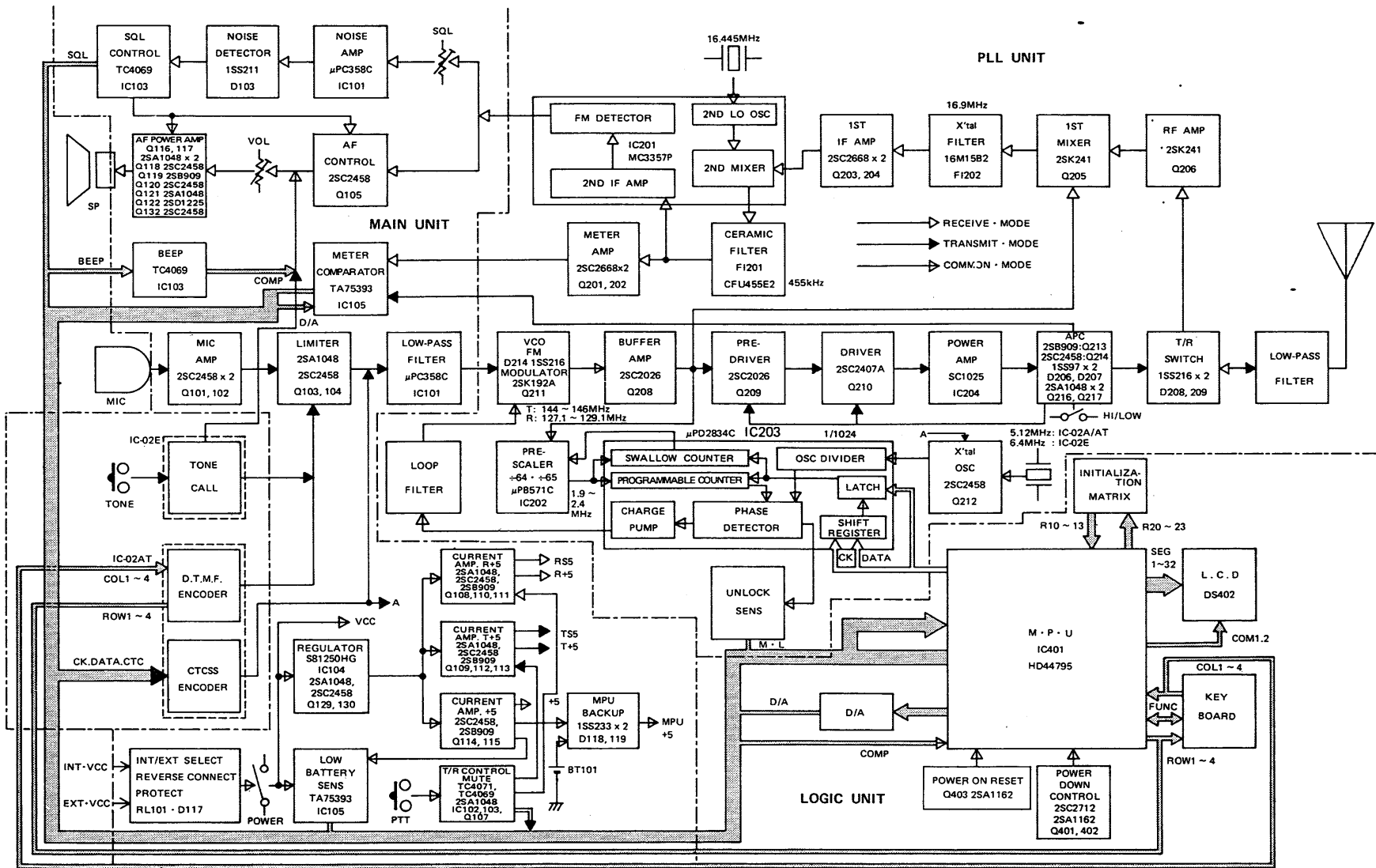

To upgrade quality, some components may be subject to change without notice.



ICOM INCORPORATED
6-9-16, KAMIHIGASHI, HIRANO-KU,
OSAKA 547, JAPAN

A-0710A Printed in Japan
Copyright © 1988 by Icom Inc.